

Information document No.: XHY-20180130

**APPLICATION FOR EXTENSION APPROVAL OF A TYPE OF PNEUMATIC TYRE  
ACCORDING TO ECE REGULATION No.30, 02 SERIES OF AMENDMENTS**

1. Manufacturer's name and address : QINGDAO KEBEK TIRE CO., LIMITED  
LinGong Road, MengYin Economic Development  
Zone, LinYi City, ShanDong Province, 276200  
P.R. China
2. Tyre type designation:  
2.1. Brand-name(s)/trademark(s) : HILO; FULLRUN; ANCHEE; ANNAITE; XINGHONGYUAN;  
AUTOGRIP; PREMME;  
2.2. Trade description(s)/Commercial name(s) : SPORT XV1; FRUN-FOUR; GRIP4000; CROSSMAX; AC 828;  
AN 616
3. If applicable, name and address of manufacturer's representative : Not applicable
4. Summarized description:  
4.1. Tyre size designation : 255/70R16  
4.2. Category of use : Normal/snow/special use/temporary use  
4.2.1. For special use tyre  
-Professional Off-Road : Yes/no  
-Tread depth : Not applicable  
-Void to fill ratio : Not applicable  
4.3. Structure : Diagonal/bias-belted/radial/run-flat tyre  
4.4. Speed category symbol : H  
4.5. Load-capacity index : 111
5. The overall physically measured dimensions : Annex-5/Calculated  
- Overall section width : 267  
- Outer diameter : 759
6. Factor "X" : 0.70
7. Ply-rating number of diagonal(bias-ply) tyres : Not applicable
8. Rims on which the tyre can be mounted : 7.5J  
6.5J,7J,8J,8.5J
9. Measuring rim and test rim : See attached test report
10. State whether the tyre is : Tubeless/ tube type
11. State whether the tyre is : Standard/reinforced/T-type temporary use spare tyre
12. Test pressure : See attached test report
13. The tire side wall and tread pattern's Drawing No. : XHY-20180130Z
14. Extension reasons : Addition of trade description; Deletion of trade mark
15. Date of the information document : 2018.1.18

MANUFACTURER'S STAMP

SIGNATURE



THE NETHERLANDS  
(N E D E R L A N D)

## COMMUNICATION

Concerning <sup>(1)</sup>:

- ~~approval granted~~
- approval extended
- ~~approval refused~~
- ~~approval withdrawn~~
- ~~production definitely discontinued~~

of a type of pneumatic tyre for motor vehicles pursuant to Regulation number 30.

**Approval number: E4-30R-0291826****Extension number: 02**

1. Manufacturer's name and address : QINGDAO KEBEK TIRE CO.,LIMITED  
LinGong Road, MengYin Economic Development  
Zone, LinYi City, ShanDong Province, 276200  
P.R. China
2. Tyre type designation<sup>(2)</sup>
  - 2.1. Brand-name(s) or trade mark(s) : HILO; FULLRUN; ANCHEE; ANNAITE;  
XINGHONGYUAN; AUTOGRIP; PREMME
  - 2.2. Trade description(s)/ Commercial  
name(s) : SPORT XV1; FRUN-FOUR; GRIP4000;  
CROSSMAX; AC 828; AN 616
3. If applicable, name and address of the  
manufacturer's representative : Not applicable



4. Summarised description
- 4.1. Tyre size designation : 255/70R16
- 4.2. Category of use : ~~normal/snow/special use/temporary use~~<sup>(1)</sup>
- 4.3. Structure : ~~diagonal/bias belted/radial/run flat tyre~~<sup>(1)</sup>
- 4.4. Speed category symbol : H
- 4.5. Load-capacity index : 111
5. Technical service and, where applicable, test laboratory approved for purposes of approval or of verification of conformity : TÜV Rheinland Kraftfahrt GmbH  
Technologiezentrum Verkehrssicherheit  
Typprüfstelle Fahrzeuge/Fahrzeugteile  
Am Grauen Stein  
D-51105 Köln (Poll)
6. Date of report issued by that service : February 01, 2018
7. Number of report issued by that service : 86-R30-0232/18-00
8. Reason(s) of extension (if applicable) : Addition of trade description;  
Deletion of trade mark of "XINGYUAN"
9. Any remarks : ---
10. Place : Zoetermeer
11. Date : 08-FEB-2018
12. Signature :



13. The list of documents in the approval file which are deposited at the administrative service having delivered the approval and which can be obtained upon request.
- Application form relating to ECE approval for a pneumatic tyre pursuant to Regulation number 30.
  - The drawing of the tyre's sidewalls, tread and dimensioned cross-section.
  - The test report as mentioned in item 7.

---

(1) Strike out what does not apply.

(2) A list of Brand name(s)/trademark(s) or Trade description(s)/ Commercial name(s) may be annexed to this communication

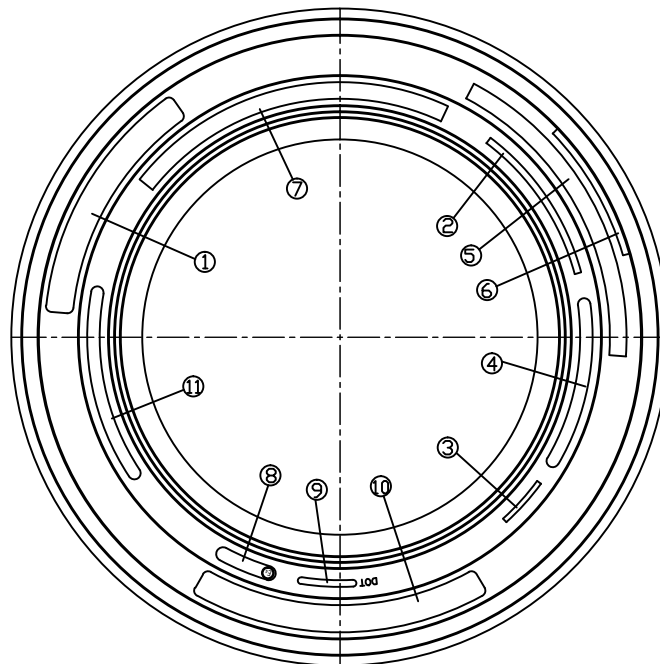
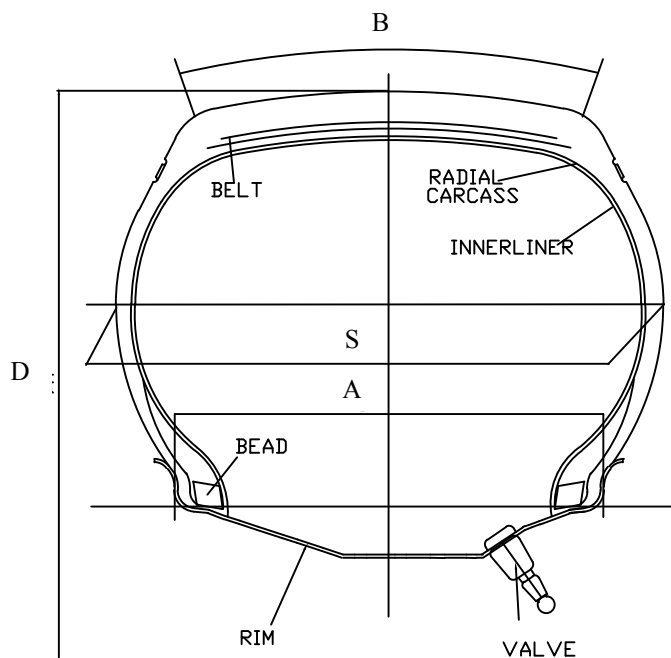

LOWER MOLD

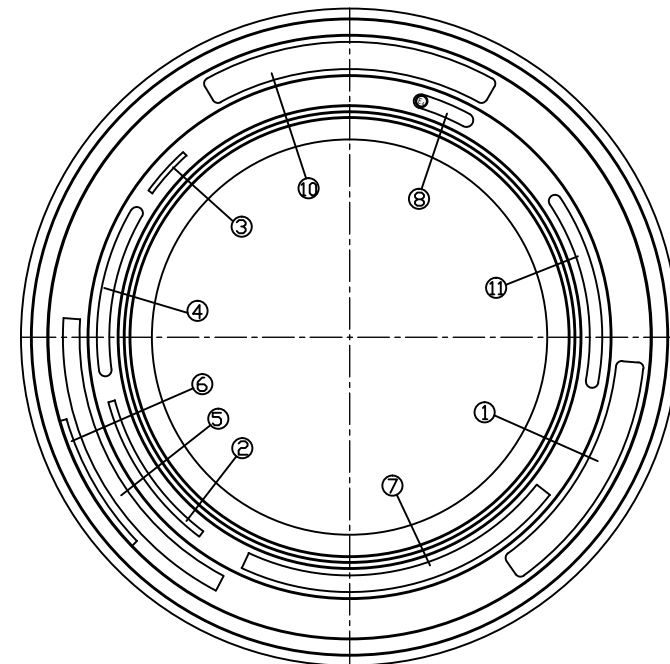

UPPER MOLD

TREAD PATTERNS  
REFER TO ATTACHMENT NO.30

1	BRAND STAMING [ REFER TO ATTACHMENT NO.30 ]									
2	TUBELESS STEEL BELTED RADIAL									
3	MADE IN CHINA									
4	MAX. LOAD 1090 kg (2403 LBS) AT 350 kPa (51 P.S.I.) COLD TREAD PLYS: 2 POLYESTER + 2 STEEL +1 NYLON SIDEWALL PLYS: 2 POLYESTER									
5	255/70R16									
6	TREADWEAR *** TRACTION * TEMPERATURE *									
7	SAFETY WARNING *****									
8	(E4) *****									
9	DOT *** ***** ****(DATE CODE)									
10	TREAD PATTERN [ REFER TO ATTACHMENT NO.30 ]									
11	255/70R16 111H M+S									
	255/70R16	111	H	TL	764	260	190	190	85	
	TIRE SIZE	LOAD INDEX	SPEED SYMBOL	TYPE	D (mm)	S (mm)	A (mm)	B (mm)	SKID DEPTH	RDW

DRAWN BY	<i>Handwritten signature</i>	CHECKED BY	<i>Handwritten signature</i>	APPROVED BY	<i>Handwritten signature</i>	QIGNDAO KEBEK RUBBER CO. LIMITED	Drawing NO.	XHY-20180130Z
----------	------------------------------	------------	------------------------------	-------------	------------------------------	----------------------------------	-------------	---------------

Autodesk

Autodesk

# ATTACHMENT NO.30

TIRE SIZE:255/70R16

## TREAD PATTERNS

E4 \*\*\*\*\*

① SPORT XV1; AC 828;  
 CROSSMAX; AN 616;  
 GRIP4000;  
 FRUN-FOUR

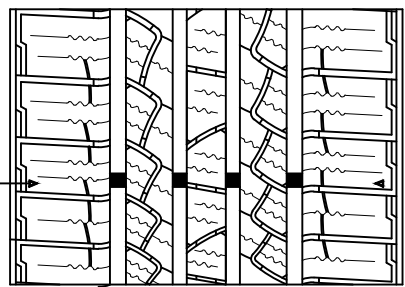

6-TWI EQUALLY SPACED  
 BOTH HALVES

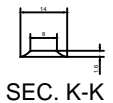

### SIDEWALL BRAND STAMPING

- ① HILO
- ② FULLRUN
- ③ ANCHEE
- ④ XINGHONGYUAN
- ⑤ ANNAITE
- ⑥ AUTOGRIP
- ⑦ PREMME

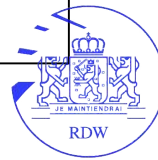

Type : 255/70R16  
Manufacturer : QINGDAO KEBEK TIRE CO.,LIMITED

---

## TEST REPORT

according to UNECE-Regulation

**Uniform provisions concerning the approval of pneumatic tyres  
for motor vehicles and their trailers**

**ECE-R30**

including all amendments until

Amend.02, Suppl. 18

---

Approval Status

UNECE approval : E4-30R-0291826 Ext.02

---

Structure of the Test Report

Item No.

0. General information
  1. Tested vehicle(s) / object(s)
  2. Test record
  3. List of appendices
  4. Statement of conformity
- 

The Test Report shall be reproduced and published in full by the client only. It shall however be reproduced partially with the written permission of the Testing Laboratory only.

Type : 255/70R16  
 Manufacturer : QINGDAO KEBEK TIRE CO.,LIMITED

## 0. General Information

- 0.1. Make (trade name of the manufacturer) : QINGDAO KEBEK TIRE CO.,LIMITED  
 0.2. Type : 255/70R16  
 0.3. Category of vehicle : Not applicable  
 0.4. Name and address of the manufacturer : QINGDAO KEBEK TIRE CO.,LIMITED  
 LinGong Road, MengYin Economic Development  
 Zone, LinYi City, ShanDong Province, 276200  
 P.R. China  
 0.5. No. of the information folder : Not applicable  
 -Date of issue : May 06, 2016  
 -Date of last change : January 18, 2018

## 1. Tested vehicle(s) / object(s)

- 1.1 Description  
 1.1.1. ~~Vehicle~~ / object  
 Commercial description : Not applicable  
 Type(s) / ~~variant(s)~~ / ~~version(s)~~ : 255/70R16  
 Identification number : See Appendix 1  
 1.1.2. Condition of ~~vehicle(s)~~/Object(s) : New / ~~used~~ / ~~pretested~~  
 1.2. Worst case selection : The determination of the worst case was done  
 according to internal procedures of the Technical  
 Service (QMA 1.301.005, section 6.2.2.2.).  
 1.3. Remarks : Not applicable

Type : 255/70R16  
 Manufacturer : QINGDAO KEBEK TIRE CO.,LIMITED

2. Test record

- 2.1. Equipment for measuring and testing : The test facilities / measurement equipment used were in compliance with the test requirements
  - 2.1.1. Specifications for the test site : Not applicable
  - 2.1.2. Subcontracting : Not applicable
- 2.2. Test results : See Appendix 1
  - 2.2.1. Test results referring to measurements : Pass /~~Fail~~
  - 2.2.2. Attributive tests : Not applicable
  - 2.2.3. Alternative test provisions : Not applicable
- Remarks concerning extension : ~~The type has been tested according to the modification(s) mentioned in appendix 0.~~  
 The new parts meet the requirements of the regulation.  
 An actual practical test of the type was not necessary.  
 The results of the previous test(s) are still valid.
- 2.3. Additional information : The results of the test refer exclusively to the object(s) mentioned under point 1. of this report.
  - Test site : QINGDAO KEBEK TIRE CO.,LIMITED  
 LinGong Road, MengYin Economic Development Zone, LinYi City, ShanDong Province, 276200 P.R. China
  - Test date : June 15, 2016
- 2.4. Remarks : Not applicable



Type : 255/70R16  
Manufacturer : QINGDAO KEBEK TIRE CO.,LIMITED

---

### 3. List of Appendices

Appendix 0 : List of modifications  
Appendix 1 : Test minutes

### 4. Statement of conformity

The in point 0.5. mentioned information folder and the type described in that comply with the requirements mentioned on page 1.

With regard to the required level of performance to be achieved, the tested items were representative for the type to be approved (see point 1.2).

The mentioned test results refer to the vehicle(s)/object(s) described under point 1.1 of this report.

Engineering Centre Shanghai, / February 01, 2018  
ZXX

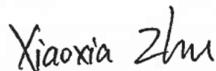

Xiaoxia Zhu  
Expert Technical Service

Type : 255/70R16  
Manufacturer : QINGDAO KEBEK TIRE CO.,LIMITED

---

**List of modifications**

**Appendix 0**

Correction of : ---

Modification of : ---

Addition of : Trade description

Deletion of : Trade mark of "XINGYUAN"

Type : 255/70R16  
 Manufacturer : QINGDAO KEBEK TIRE CO.,LIMITED

## Test minutes

## Appendix 1

## 1. Test data

## 1.1. Test object(s) markings

- 1.1.1 Trade name or mark : HILO  
 1.1.2 Tyre type designation : SPORT XV1  
 1.1.3 Plies of Tread / Sidewall : 2 POLYESTER + 2 STEEL + 1 NYLON /  
 2 POLYESTER  
 1.1.4 Tyre size designation : 255/70R16  
 1.1.5 Category of use : Snow  
 Indication of category of use : Word "M+S"  
 1.1.6 Structure : Radial  
 Indication / symbol of structure : Word "RADIAL", letter "R" in front of rim diameter  
 marking  
 1.1.7 Speed category : H  
 1.1.8 Load-Capacity Indices(L.I.) : 111  
 1.1.9 Word in case of without inner tube : Word "TUBELESS"  
 1.1.10 Word in case of reinforced tyre : Not applicable(standard tyre)  
 1.1.11 Date of manufacture : 2116

## 1.2. Dimension measurement according to Annex 6

- 1.2.1 Measuring rim : 7.5J x 16  
 1.2.2 Inflation pressure after mounting on  
 measuring rim : 3.0 bar  
 1.2.3 Inflation pressure adjusted before  
 conditioning : 1.8 bar  
 1.2.4 Conditioning of tyre : More than 24 hours  
 1.2.5 Inflation pressure readjusted after  
 conditioning : 1.8 bar

- 1.2.6 Overall width at six equally spaced points      Height of six equally spaced tread wear  
 indicators
- |       |          |    |          |    |         |    |         |
|-------|----------|----|----------|----|---------|----|---------|
| 1.    | 266.5 mm | 4. | 266.6 mm | 1. | 1.99 mm | 4. | 1.95 mm |
| 2.    | 266.9 mm | 5. | 266.3 mm | 2. | 1.94 mm | 5. | 2.00 mm |
| 3.    | 266.5 mm | 6. | 266.2 mm | 3. | 2.00 mm | 6. | 1.96 mm |
| Max.: | 266.9 mm |    |          |    |         |    |         |



Type : 255/70R16  
 Manufacturer : QINGDAO KEBEK TIRE CO.,LIMITED.

- 1.2.7 Circumference : 2385 mm
- 1.2.8 Outer diameter : 759.2 mm
- 1.2.9 Tread depth / void to fill ratio in case of special use tyre : Not applicable

**1.3. Load/speed performance test according to Annex 7**

- 1.3.1 Test machine : TJR-2-PC(Y)
- 1.3.2 Diameter of test drum : 1.707 m
- 1.3.3 Test rim : 7.5J x 16
- 1.3.4 Inflation pressure adjusted before conditioning : 2.8 bar
- 1.3.5 Conditioning of tyre : More than 3 hours
- 1.3.6 Test-room temperature : 29.0 - 29.1 °C
- 1.3.7 Inflation pressure readjusted after conditioning : 2.8 bar
- 1.3.8 Circumference after conditioning, before testing : 2391 mm
- 1.3.9 Outer diameter after conditioning, before testing : 761.1 mm
- 1.3.10 Test load (80%) : 872 kg

Step	Step-Duration [min]	Total Duration [min]	Actual speed (km/h)
1.	10	10	0 – 170
2.	10	20	170
3.	10	30	180
4.	10	40	190
5.	20	60	200

- 1.3.11 Conditioning after testing : More than 6 hours
- 1.3.12 Circumference after conditioning, after testing : 2403 mm
- 1.3.13 Outer diameter after conditioning, after testing : 764.9 mm
- 1.3.14 Difference outer diameter before and after testing (max. 3.5 %) : 3.8 mm  
: 0.50 %
- 1.3.15 Inspection after test : The tyre does not exhibit tread separation, ply separation, cord separation, chunking or broken cords.

**2. Remarks** : The test data mentioned of Appendix 1 refer to report No.: 86-R30-0205/16-00 corresponding to type approval No.: E4-30R-0291826 Ext.00.

